

Profilbefestigung vertikal
profile attachment vertical

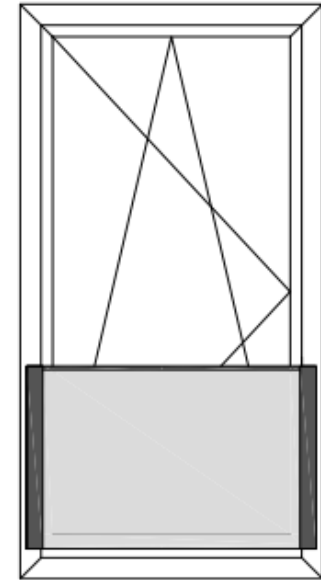

Glasbreite min. 500 mm / max. 3000 mm
Glass width min. 500 mm / max. 3000 mm

Glashöhe min. 400 mm / max. 1200 mm
Glass height min. 400 mm / max. 1200 mm

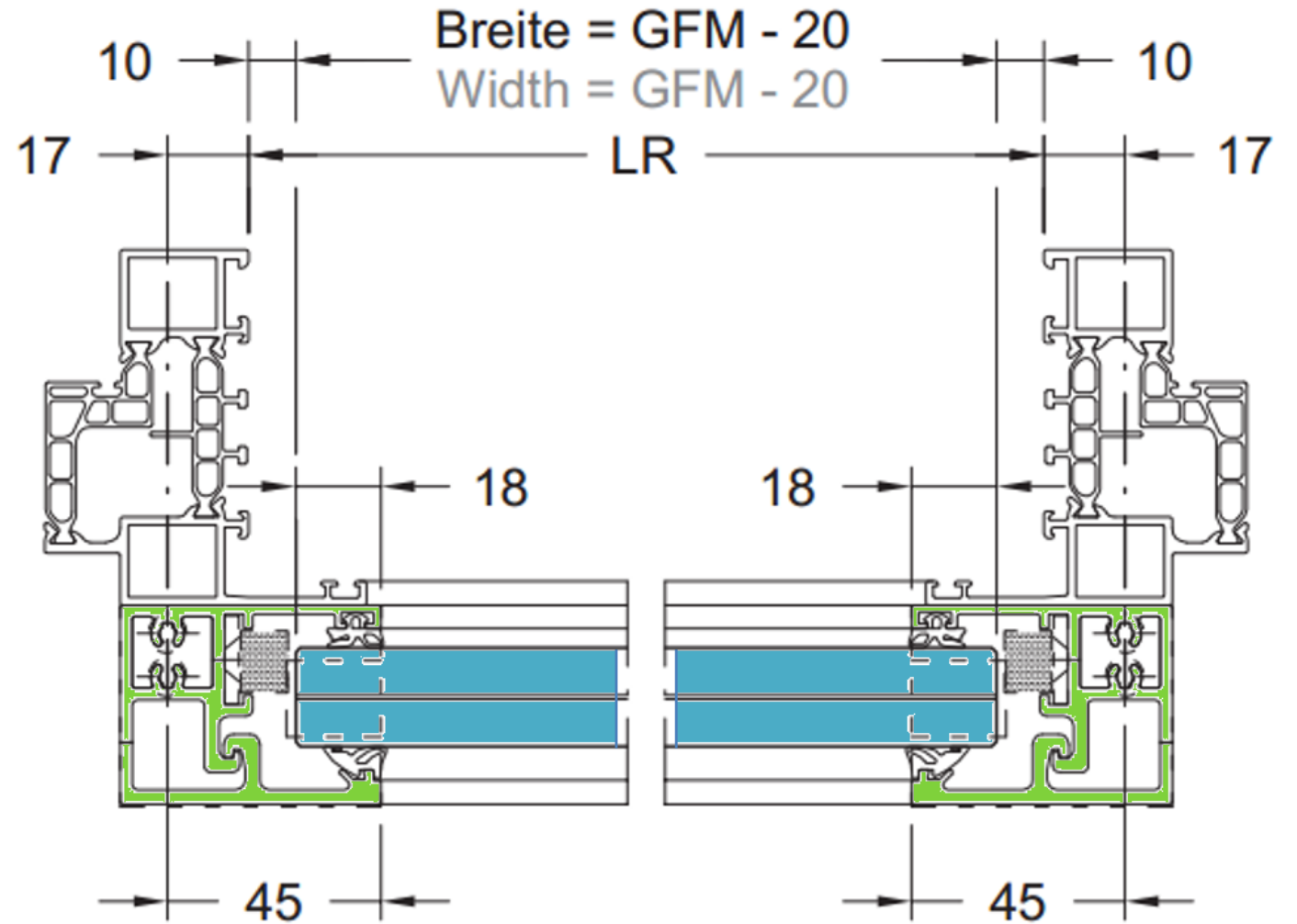
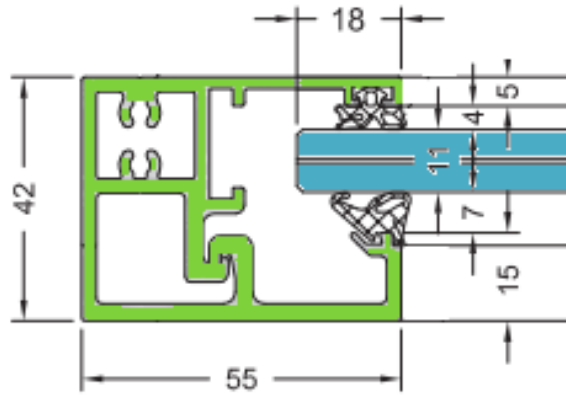

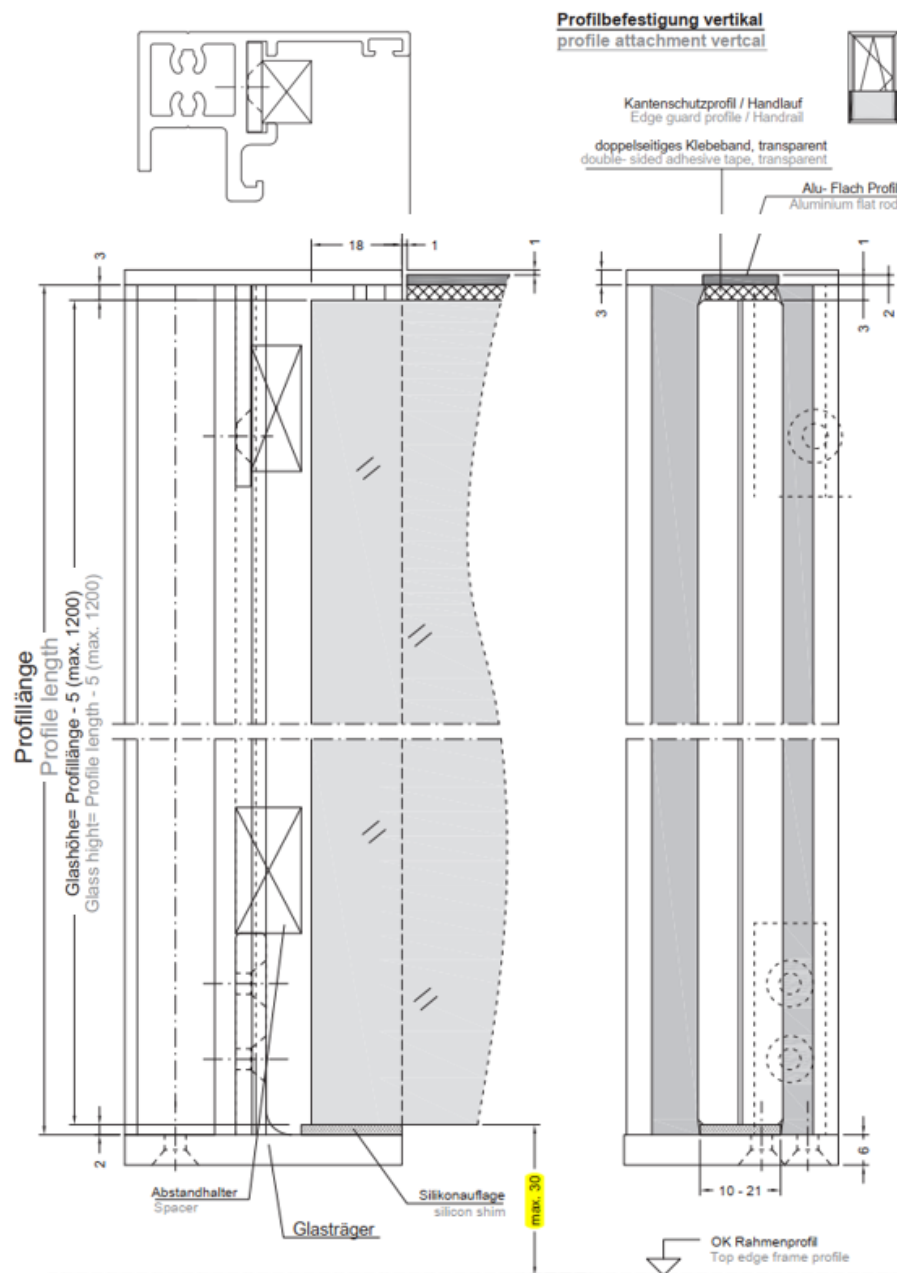

Glasberechnung
glass calculation

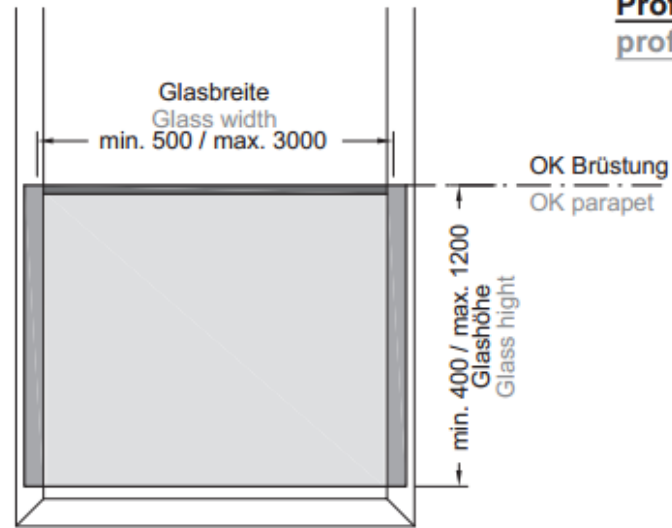

Profilbefestigung vertikal
profile attachment vertical

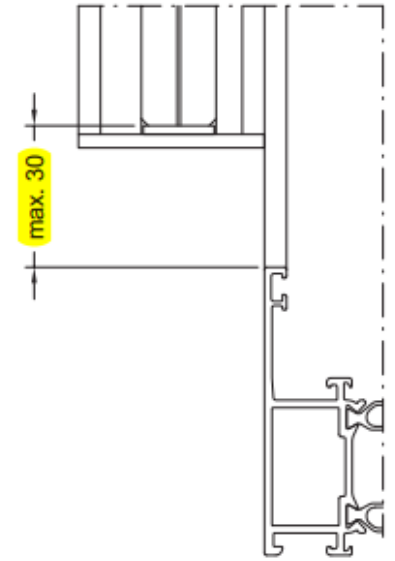
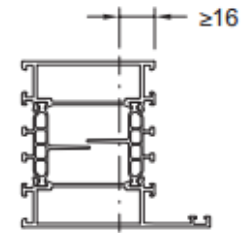

Befestigung an unterschiedlichen Blendrahmenbreiten
Attachment to different frame widths

